

Article number: 586PLG186

Description: Mini Push-in PLG186, angle, G 1/8" hose Ø6

Measures

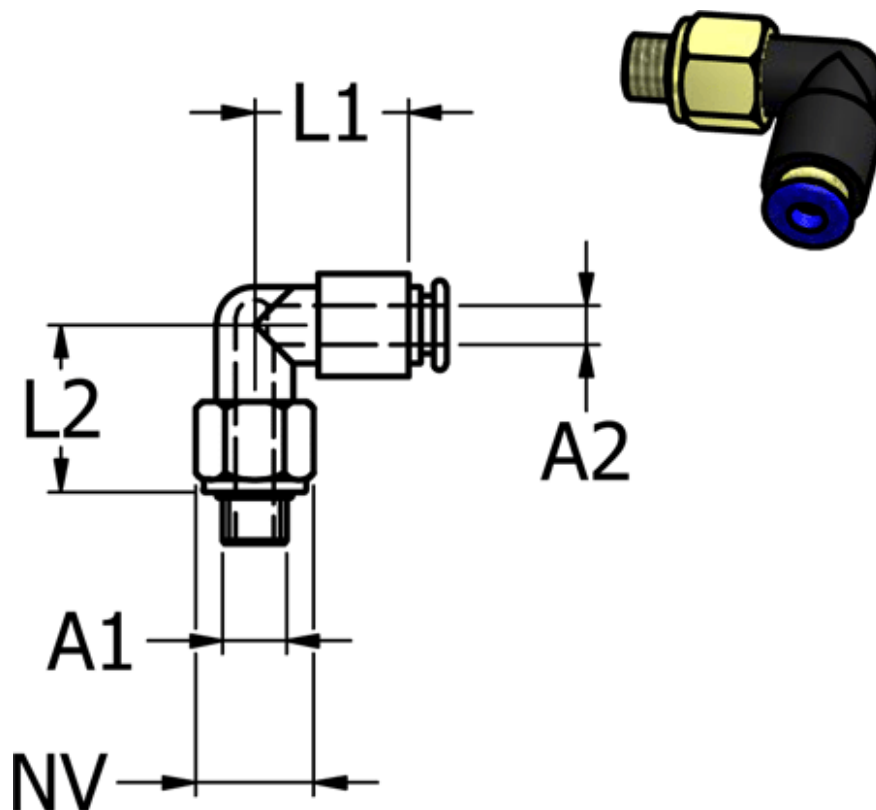

Ext. hose diameter A2 = 6 mm

L1 = 16

L2 = 16.5

NV = 13

Thread A! = G 1/8"